

San Bernardino County Flood Control District

DEBRIS AND EROSION CONTROL



County of San Bernardino

Department of Public Works

INTRODUCTION

The San Bernardino County Flood Control District was created by the California Legislature under the San Bernardino County Flood Control District Act, Chapter 73, Statutes of 1939, adopted and effective April 20, 1939.

The District was formed as an urgency and progressive measure for the preservation and promotion of public peace, health, and safety as a direct aftermath of the disastrous March 1938 floods, which took many lives and caused millions of dollars in property damage.

Through the years, the District has been primarily concerned with control of flood waters in major watercourses and channels under the jurisdiction of the District. Due to the vastness of our County, it has been impossible for us to provide assistance to individual property owners Countywide.

The district has made this information booklet available to you to assist you in coping with your individual flood and debris problems. The protection devices shown are relatively inexpensive and can easily be applied.

We wish to extend our gratitude to other flood control districts and agencies which have contributed toward the compilation of data contained in this booklet.

HOME PROTECTION METHODS ARE OF TWO TYPES:

1. EMERGENCY
2. LONG RANGE

The following material discusses both types:

EMERGENCY

| | |
|--|----|
| Debris flows | 3 |
| Do it yourself debris control aids | 4 |
| General rules | 5 |
| Sandbags | 7 |
| Window and door protection | 11 |
| Wooden deflectors | 12 |
| General comments | 15 |

LONG RANGE

| | |
|---|----|
| Erosion and fire control in newly developed area | 17 |
| Ground cover | 18 |
| Shrubs and trees | 19 |
| Erosion control in burned areas | 21 |
| To landscape burned or unburned areas and reduce fire hazard | 23 |

UNPROTECTED HOMES

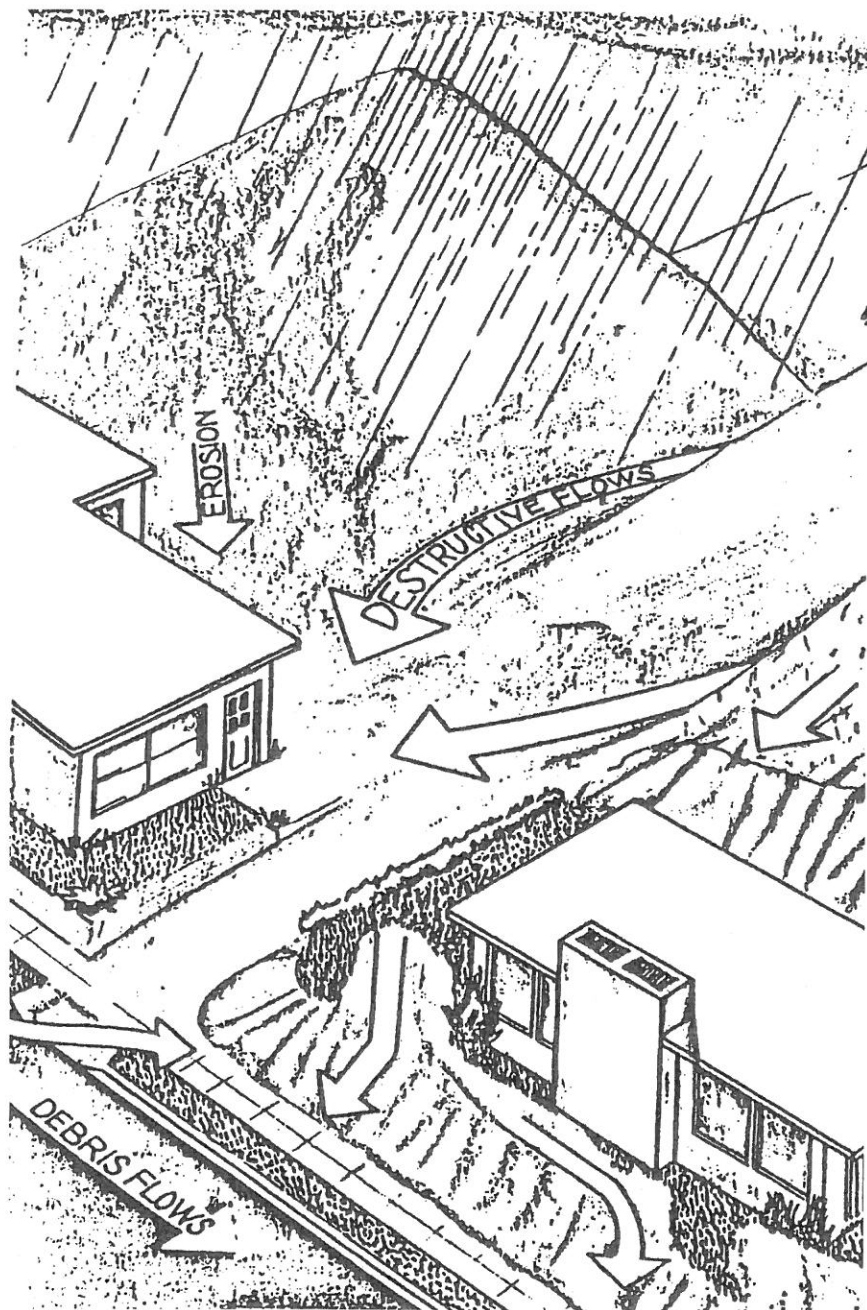

DEBRIS FLOWS

Another equally dangerous problem, usually in hillside or mountainous areas is **debris flows**. Remember that debris flows:

CONSIST of large quantities of soil, rocks, boulders, trees or brush being moved by flood waters.

OCCUR when flood waters flow over hillside and natural streambed areas and are most serious in areas denuded by recent fire or grading.

ARE highly destructive and leave large quantities of sediment and rocks in their paths when the storm subsides.

CONTAIN sufficient strength to destroy objects in their path.

CAN be controlled or directed to reduce property damage.

DO NOT UNDERESTIMATE THE POWER OF DEBRIS FLOWS

Early planning and early action can reduce possible damage during the storm season. Once the debris flows start, it is too late to plan protection.

START IMMEDIATELY!!

DO IT YOURSELF DEBRIS CONTROL AIDS

ARE not expensive when compared to the protection received.

CAN be installed with normal household tools.

CONSIST of materials readily available at your local lumber yard

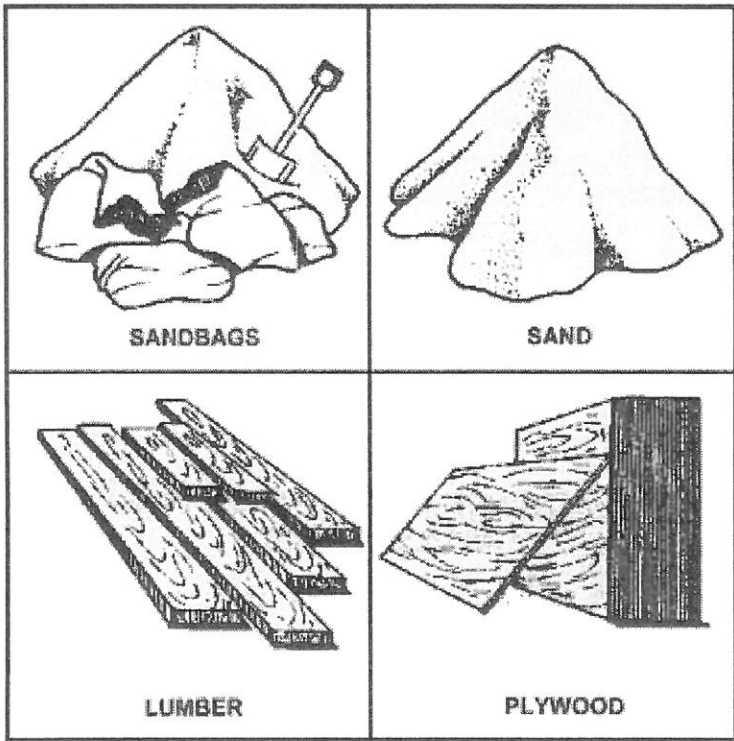

GENERAL RULES

Each situation differs; however, basic rules can be followed in all cases involving debris movement.

NEVER underrate the power of debris flows.

TRY to direct debris flows away from improvements.

AVOID trying to confine the flows more than is absolutely required.

CLEAR a path for the debris.

USE your house or building as a deflector if necessary.

ALWAYS place protection to deflect debris, not to dam it.

DEBRIS will often enter a building through windows... board them up!

REMEMBER to protect your most valuable property first... your home.

THEN consider what time and money are available to protect other less valuable objects, such as swimming pools or planting.

TRY to work with adjacent affected property owners.

BE prepared to sacrifice the use of portions of your property to achieve good protection.

The following eight pages cover typical installations of sandbags, timber and plywood to protect buildings and grounds.

SANDBAG FILLING AND PLACING

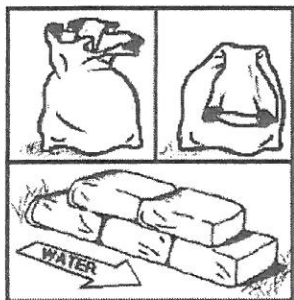

Sandbag placement.

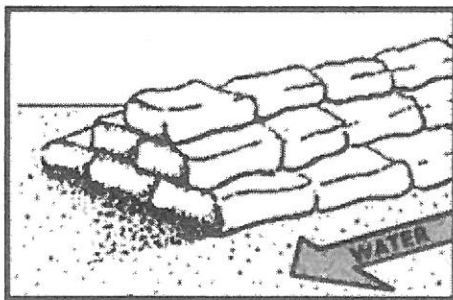

Pyramid sandbag stacking.

BUILDING PROTECTION

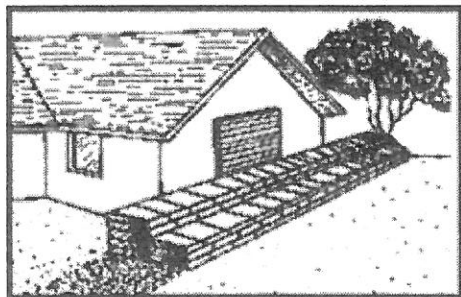

Sandbag stacking against buildings.

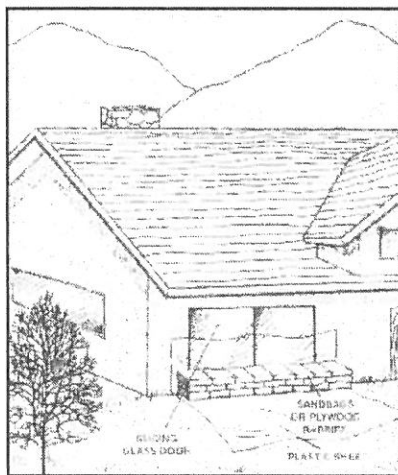

Sliding glass door sealing.

SANDBAGS

Sandbags, when properly filled and placed, will redirect storm and debris flows away from property improvements.

FILLING

1. Fill sandbags one-half full. Sand is suggested if readily available; however, sand is not mandatory, and any local soil may be used.
2. For a more durable bag with increased effective life, mix 10 parts of sand or soil with one part of cement. The materials can be mixed and placed dry. After all bags are in place, a light sprinkling of water is recommended. This technique is only effective with burlap sandbags and will not work with plastic sandbags.

PLACING

1. Fold top of sandbag down and rest bag on its folded top.
2. It is important to place bags with the folded top toward the upstream or uphill direction to prevent bags from opening when water runs by them.
3. Care should be taken to stack sandbags in accordance with the illustrations. Place each sandbag as shown, completing each layer prior to starting the next layer. Limit placement to two layers unless a building is used as a backing or sandbags are pyramided.

LIMITATIONS

1. Sandbags will not seal out water.
2. Sandbags deteriorate when exposed for several months to continued wetting and drying.
3. Sandbags are basically for low-flow protection (up to two feet). Protection from higher flows requires a more permanent type of structure.

CAUTION

Do not use straw or bales of hay in lieu of sandbags. They do not perform as well as sandbags and may be washed away.

DIRECTING DEBRIS AWAY FROM BUILDINGS

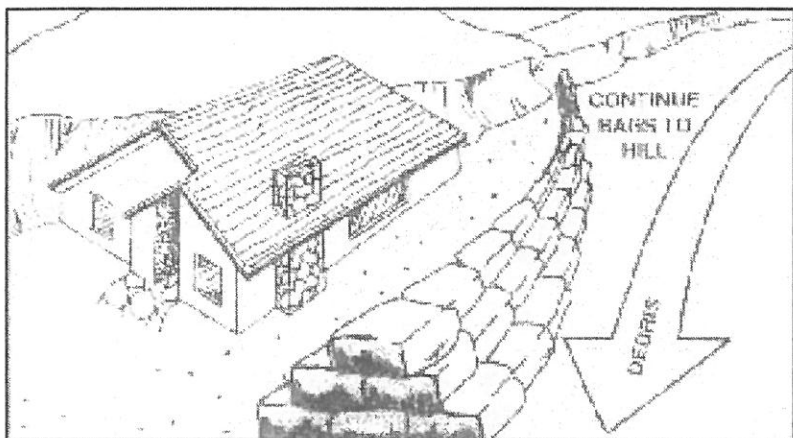

CONTROLLING DEBRIS OR STORM FLOWS IN STREETS

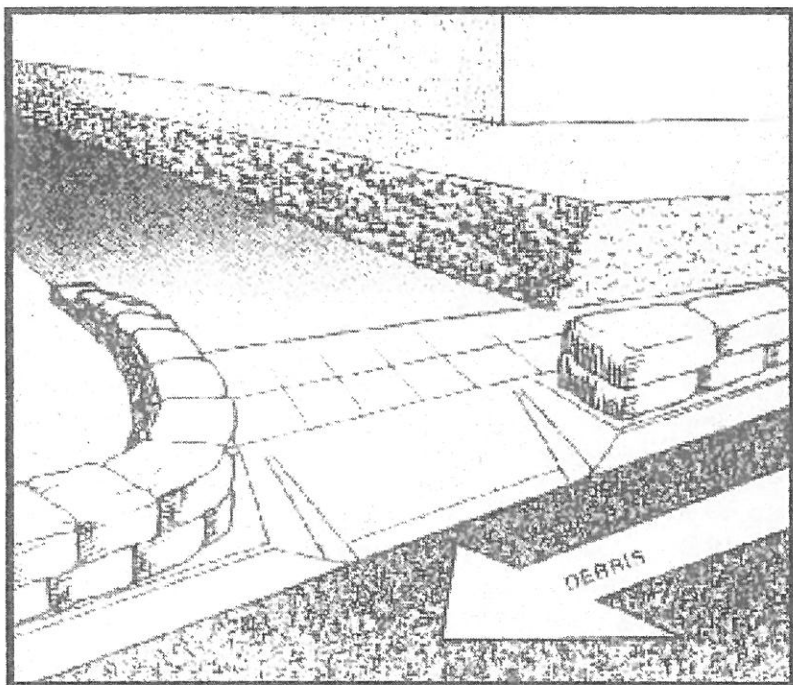

DIRECTING FLOWS BETWEEN BUILDINGS

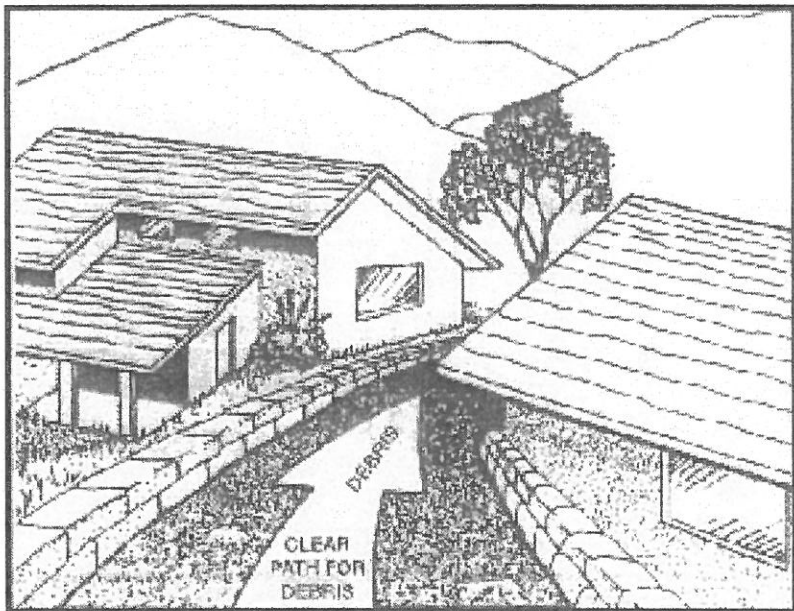

BUILDING PROTECTION

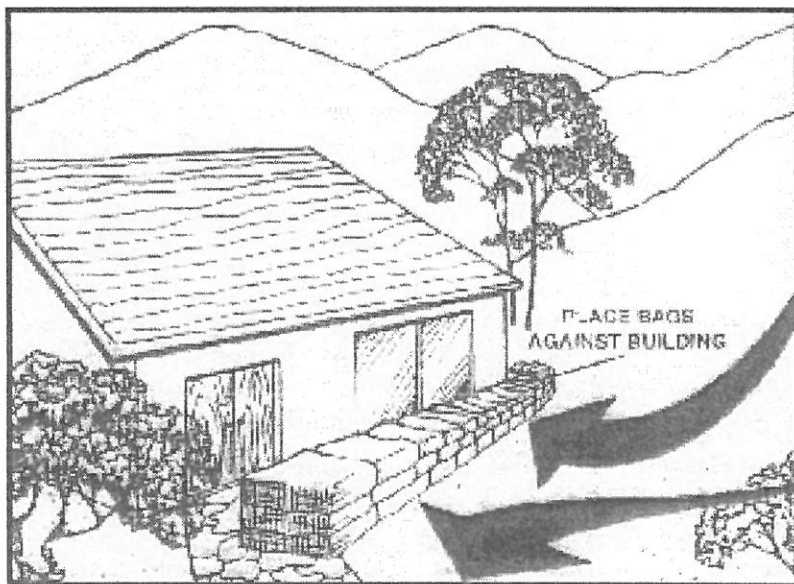

TYPICAL WINDOW AND DOOR PROTECTION

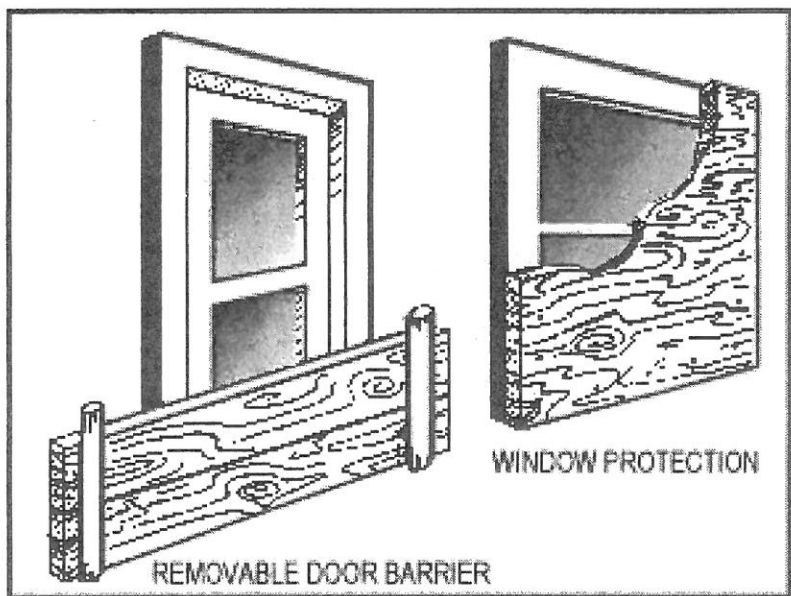

USE OF WINDOW AND DOOR PROTECTION

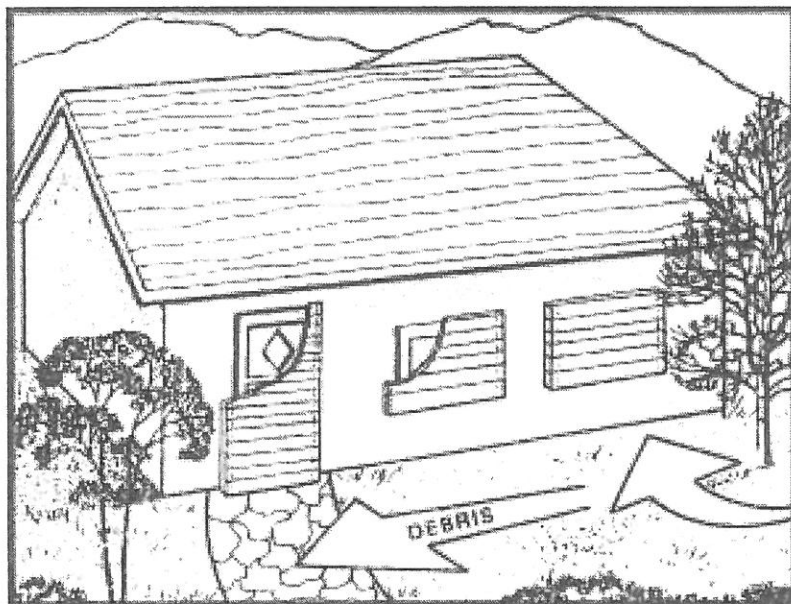

WINDOW AND DOOR PROTECTION

PROVIDE protection against debris entering around doorways and windows by use of boards or plywood.

COVER doors and windows completely with plywood, if affected by the hazard, and use an alternate entrance.

USE low-grade plywood to overlap windows, vents and doors 3 to 4 inches on all sides.

SECURE each sheet of plywood with four or more nails, screws or bolts; stakes and boards may also be used to wedge barriers in place. As an alternative, standing pipes on both sides of a door may be used to secure a removable barrier.

MATERIALS can be dismantled after the storm season and stored year-to-year.

WOODEN DEFLECTORS

- USE** low-grade lumber and overlap section with protruding end facing downstream.
- DRIVE** stakes to at least one-half their length to ensure proper anchorage.
- PLACE** deflectors on solid, level soil if possible to reduce the hazard of undercutting.
- DO NOT** attempt to use the lumber as a dam.
- SOIL** firmly packed behind the deflector will provide needed additional strength.
- PLACE** sandbags against the house if debris deflector required is greater than three feet.
- IF** deflector required is more than three feet in height, house will have to be protected with sandbags and used as a deflector.

DIRECTING DEBRIS AWAY FROM BUILDINGS

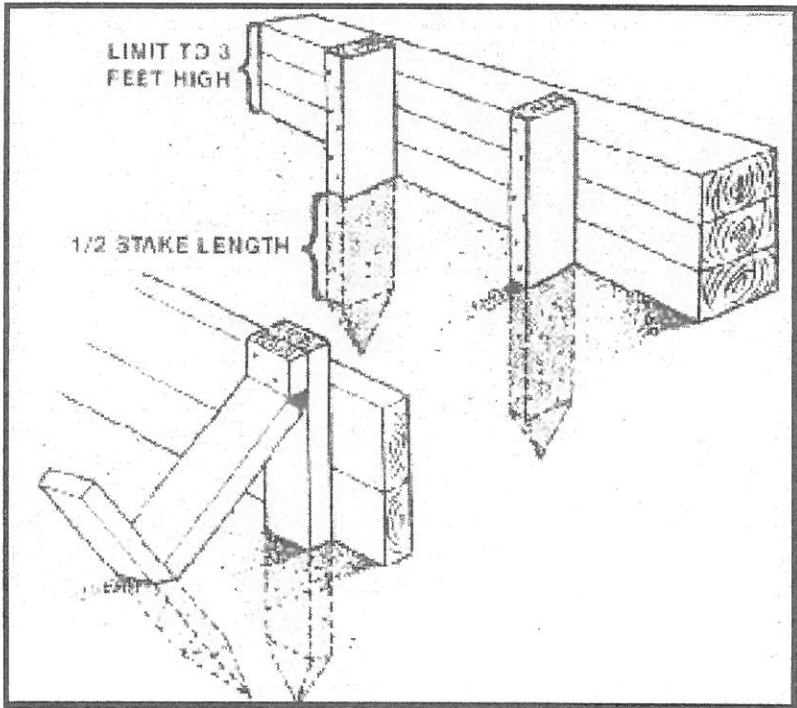

TIMBER DEFLECTOR

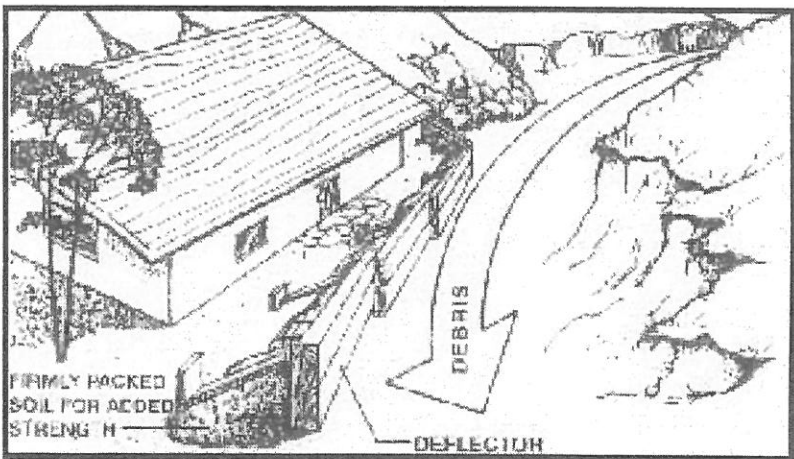

HOMES PROTECTED FROM MAJOR DAMAGE

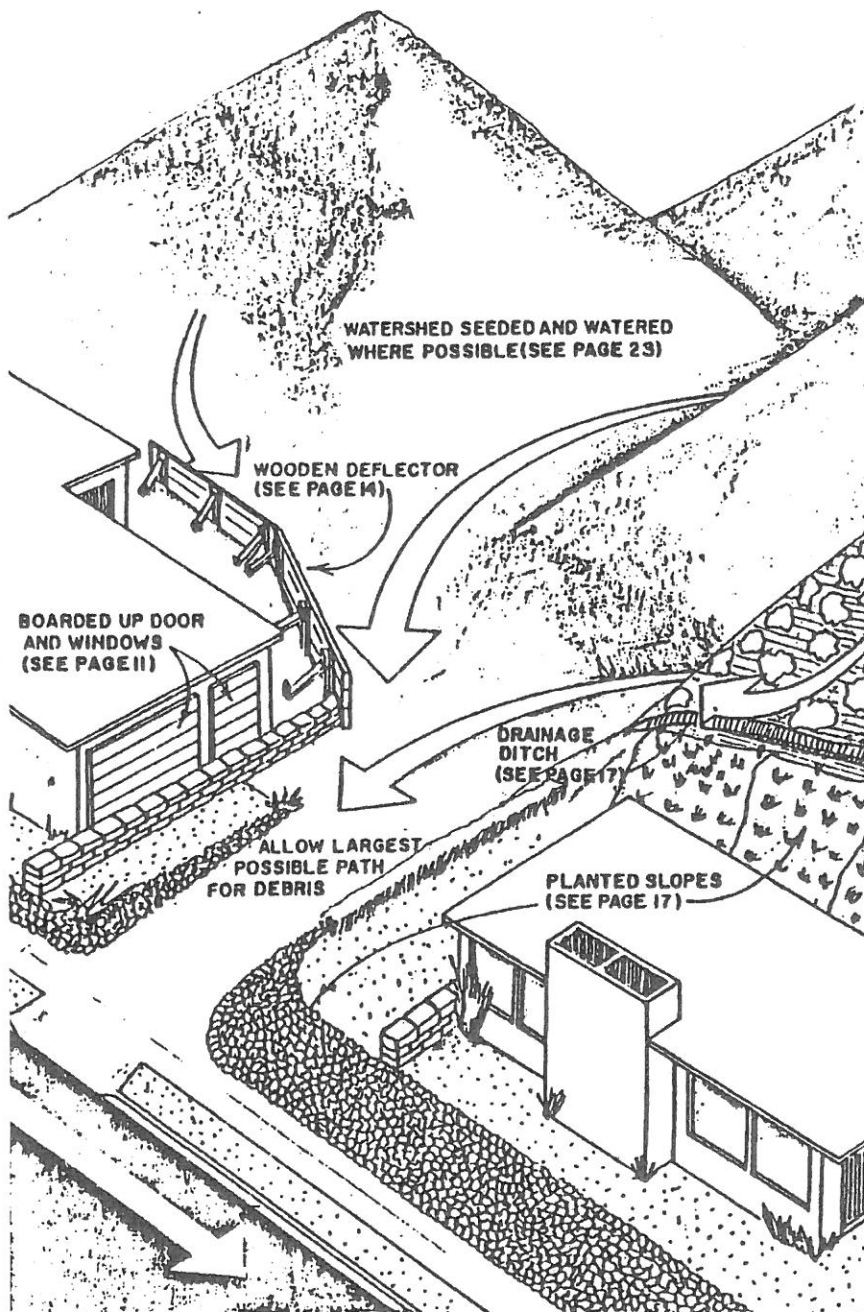

GENERAL COMMENTS

DO NOT underestimate the power of debris flows and flood waters.

DO NOT wait until the storm season to start your planning and installation of flood, debris, and erosion control facilities. Start as soon as possible. Once debris flows and flood waters begin, it is usually too late to install protection.

PROTECTION is not always pleasing to the eye and appearance should not dictate location or type of installation.

BE prepared to personally observe and maintain your installations during storm periods, for in many cases a minor correction will prevent major failure. However, do not take any unnecessary risks.

SHOULD your flood, debris, and erosion control problems appear to warrant facilities in excess of the measures described in this pamphlet, it is recommended that you consult a competent expert for additional advice.

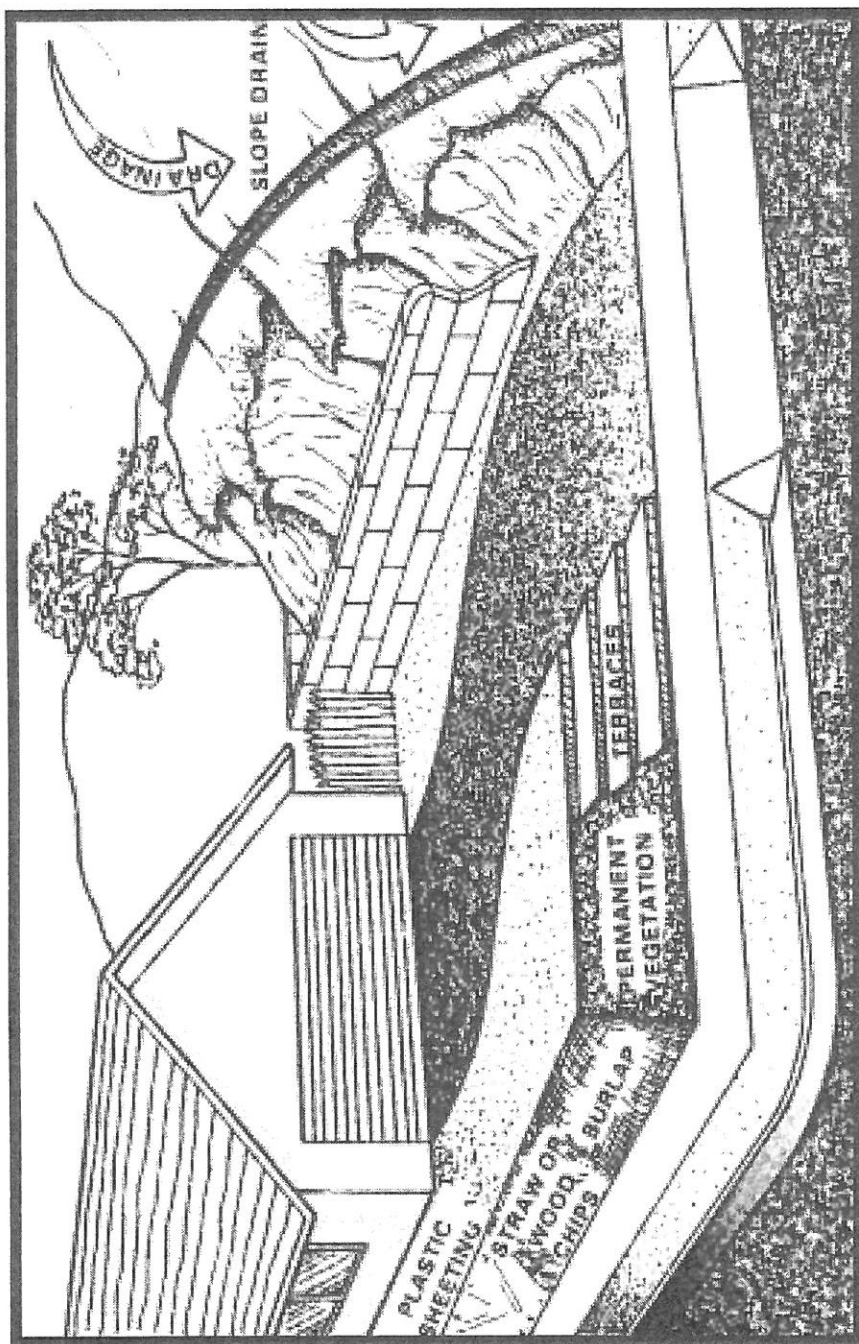

EROSION AND FIRE CONTROL IN NEWLY DEVELOPED AREAS

(See illustration on opposite page)

CONTROLLING WATER FLOWING INTO PROPERTY Dig a small ditch with a hoe or shovel fairly close to the upper edge of the property. Build the ditch nearly on the horizontal to ensure slow water movement. Provide for the ditch to drain into a natural water-course or onto street pavement or to a well-vegetated area.

CONTROLLING RUNOFF ON SLOPES Dig the same type of small ditch at the top of each steep slope. Do not allow large amounts of water to concentrate along one route. On soils especially susceptible to erosion, additional protection can be gained by using inexpensive plastic sheeting. These sheets should be overlapped like shingles and securely tied or weighted down so that the majority of water does not reach the soil. Shrubs may be planted through the plastic by cutting a hole just large enough for growth. Where ditches are used in unstable soil, the ditch should be sowed with perennial grasses. NOTE: Plastic sheeting should not be used as a permanent solution as it retards vegetation establishment.

STRENGTHENING THE SOIL TO RESIST EROSION Straw or wood chips are effective in holding the soil in place. They have the added value of increasing the organic content of the soil. Either material should be worked into the top few inches of the

soil. Place a covering of chips 1 inch (or less) as slope and soil conditions indicate. Nitrogen fertilizer should be added.

Woven burlap can be laid on the slope and tied down with stakes to prevent lifting by wind or water. Regular planting procedures can be followed before laying the burlap since it will not interfere with establishing growth on the slope. The burlap will decompose eventually, but will remain long enough for vegetation to become well established.

GROUND COVER

The following ground covers are recommended for most hillside areas:

ICEPLANTS are not as adaptable to soil erosion control as some other plants because of their limited root systems. They are heat and drought tolerant, but will stand little traffic. These plants root easily from pieces taken from established plantings. They grow well on a hillside if kept moist until a root system develops. In recent fires, they did well as barriers to flame when well irrigated and free from weeds and litter. Some of the available species suitable for replanting slopes are:

| | |
|--------------------------|--------------------|
| Fig Marigold | Bush type Iceplant |
| Rose Iceplant | Trailing Iceplant |
| White Iceplant | Croceum Iceplant |
| Red Spike Iceplant | Purple Iceplant |
| Yellow Trailing Iceplant | Redondo Creeper |

**AFRICAN
CREEPING
DAISY**
(*Osteospermum*)

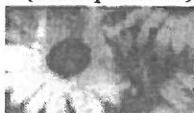

Is a good hardy cover for banks and erosion control. It has a vigorous trailing growth and remains an attractive light green year round. Plants grow 12 to 18 inches high and bloom in early spring with daisy flowers about 2 inches in diameter.

**ALGERIAN
IVY**

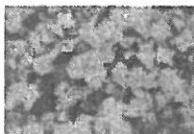

Is a widely-used ground cover with large, glossy leaves, widely spaced on the stem. Once established, it grows rapidly and will not carry fire easily if kept free of weeds. It prefers heat and sun, but must have water, since the leaves burn in hot weather if allowed to get dry. Plant on 18- to 24-inch squares.

SUNROSE

Is somewhat fire retardant. It grows to 1 foot high and flowers in the spring in several colors.

**WOOLLY
YARROW**

Is an evergreen with blue-green foliage. This plant likes sun and is drought tolerant. It spreads rapidly, grows 12 to 18 inches high, and holds soil very well. The flower head must be removed to reduce litter and expose the gray, evergreen growth of matted fern-like leaves at the base. Space them in 12- to 18-inch squares.

SHRUBS AND TREES

The following are recommended shrubs and trees:

**BROWN-EYED
ROCKROSE** Is a low, spreading evergreen shrub, which is drought and fire resistant.

**CALIFORNIA
LAUREL** Is a California native tree recommended for erosion control and fire resistance.

CALIFORNIA PEPPER Is a drought-tolerant tree. This tree shows fair resistance to fire when it is well maintained and litter is not allowed to accumulate.

CARMEL CREEPER Is a low-growing, drought-resistant, evergreen shrub with thick leaves and blue flowers in the spring. It is used as individual specimens or in clumps of two or three plants. A single plant will spread up to 10 feet wide.

CAROB Is a readily available tree commonly used in landscapes, parks, and streets in Southern California. It is pest free and tolerant of alkaline soil and drought. It also shows fire resistance.

ITALIAN BUCKTHORN Is a large evergreen shrub or small tree with green leaves. It bears blue berries in the fall, and is extremely drought-tolerant.

LEMONADE BERRY Is a native shrub that is very drought-tolerant once it is established.

OLEANDER Is a sturdy, tough, attractive summer-flowering shrub that is drought-tolerant. The plant grows to a height of 20 feet and may reach a width of 26 feet. It will grow in any soil and can withstand wind and heat. This shrub is quite fire-resistant even under non-irrigated conditions.

Caution: Although widely grown, it should be realized that all parts of this plant, including dried leaves, are poisonous. A child can become severely ill from eating a few leaves. The smoke from burning Oleander brush affects some people.

TOYON Is one of the best California natives. This drought-resistant plant bears red berries that remain for many months. It should be used as a large specimen shrub or tree.

EROSION CONTROL IN BURNED AREAS

PLANTING Is similar to planting in newly developed areas.

STRESS Rapid growth ground covers.

PLANT Throughout burned area.

WATERING May be necessary to assure early growth.

REMEMBER Rains can normally be expected to start in October, so plant now!

The following are recommended grass types:

ANNUAL RYE GRASS Is most commonly planted in burned area. It is less desirable than barley for permanent landscapes. A percentage of the seed will be perennial rye grass, which will carry over in following years and may be difficult to dispose of.

BARLEY Is an annual grass, useful for temporary plantings prior to permanent landscaping. It reseeds, but can be prevented from reseeding by clipping off the seed head. If irrigated, it germinates readily and gives immediate cover on slopes.

BIRD'S FOOT TREFOIL Is a legume that thrives in extreme environments, providing a low cover, either mowed or unmowed.

BLANDO Is a good annual native grass that reseeds itself.
BROME It gives a quick cover and grows 6 to 12 inches high, depending on available moisture to germinate, but will survive on natural rainfall once established.

SMILO and HARDING GRASSES Are stout perennials with flower heads 2 to 5 feet tall. They retain their green color longer than most grasses and have the advantage of reproducing readily. Although not fire-retardant, they will not create a great fire hazard, and burning can be controlled easily. Irrigation is necessary if the soil surface is dry.

NOTE: For more information on drought-resistant and/or fire-resistant ground covers, shrubs, trees and grasses, contact your local nursery.

UNCONTROLLED CHAPARRAL GROWTH

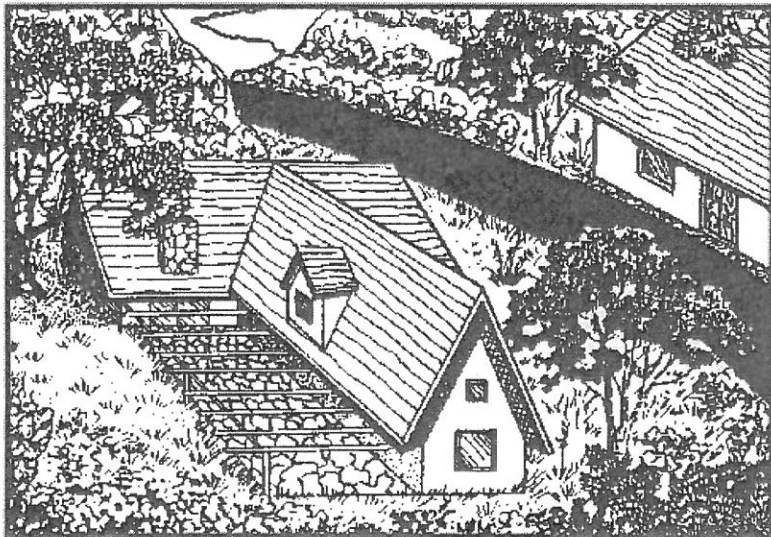

TO LANDSCAPE BURNED OR UNBURNED AREAS AND REDUCE FIRE HAZARD

PREVENT Erosion with: Quick growing, fire retardant ground covers planted on contours, burlap mats, straw mulch, or chemicals.

CONTROL Regrowth of chaparral-type brush.

PLANT Grass or succulent ground covers surrounding all structures.

PLANT Only fire-retardant ornamentals.

PLANT Screens of fire-retardant shrubs or trees where ground cover or grass ends.

HOMES PROTECTED BY CLEARING

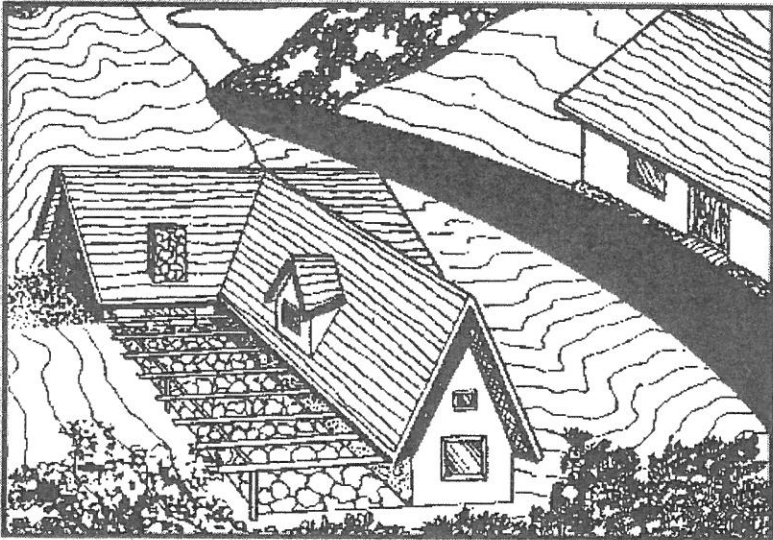

- ELIMINATE*** Or reduce chaparral-type plants that serve as fuel.
- LEAVE*** Space between remaining shrubs and trees so they will not carry a fire easily.
- KEEP*** Landscape clean. Remove litter under trees and shrubs and prune out dead growth. Remove dead and dried portions of ground covers and succulents.
- INCREASE*** Effectiveness of fire-retardant plantings with a high pressure sprinkler system.
- NATIVE*** Should be cleaned with 30 feet of buildings and brush
- BRUSH*** limited to 18 inches in height to within 70 feet of buildings.
- ONLY*** A limited number of specimen shrubs and trees can be allowed within 30 feet of a building.

CONTACT INFORMATION

Flood/Erosion

San Bernardino County Emergency Operations Center 909-356-3981

Road Conditions

Caltrans 909-383-4631

National Forest Information

San Bernardino National Forest 909-382-2600

Tree Removal

California Department of Forestry and Fire Protection 909-881-6900

San Bernardino County Hazardous Tree Abatement 909-336-7080

**To report a fire,
The public should call 911**