

**SAN BERNARDINO COUNTY FIRE PROTECTION DISTRICT  
COMMUNITY SAFETY DIVISION**



620 South 'E' Street  
San Bernardino, CA 92415-0179  
(909) 386-8400

Standard Number

**A - 1**

Revision Date:  
July 1, 2023

**FIRE PREVENTION STANDARD**

**FIRE APPARATUS ACCESS ROAD DESIGN, CONSTRUCTION AND MAINTENANCE**

**AUTHORITY**

Sections 102.9, 103 and 104 of the 2022 California Fire Code (CFC) and Sections 4 and 8 of Ordinance 23-01 of the San Bernardino County Fire Protection District Fire Code (Fire Code) state that the Fire Code Official of the San Bernardino County Fire Protection District (SBCFPD) shall have the authority to adopt policies, procedures, rules, and regulations in order to clarify the application of the Fire Code and to determine requirements not specifically provided for by the Fire Code. For further requirements on this subject, see sections 503.1 and 503.2 of the 2022 California Fire Code. This Standard may be modified with the approval of the Fire Code Official.

**PURPOSE**

The purpose of this Standard is to provide for roadways that allow for safe, quick and reliable access by emergency response fire apparatus onto premises to be protected.

**SCOPE**

This Standard shall apply to the design, construction and maintenance of all new fire apparatus access roads within the jurisdiction, as well as fire apparatus access roads at existing facilities when applied at the discretion of the Fire Code Official.

**DISCLAIMER**

*These Standards may change without notice. Whenever applicable statutes, regulations and Standards are updated and adopted, the latest shall apply. Please contact the Community Safety Division at (909) 386-8400 to determine if these Standards have changed. These requirements do not exempt any individual from complying with other applicable state, county, or city codes and Standards.*

**SUBMITTALS**

- 1) The applicant shall submit the plans and all required documentation online through the San Bernardino County EZOP website, <https://wp.sbcounty.gov/ezop>  
**NOTE:** If the project is in the City of Fontana please contact (909) 428-8890 for submittal information.
- 2) All pages of plans shall have a three-inch (3) by three-inch (3) box labeled "FOR FIRE DEPARTMENT USE ONLY" located in the bottom right corner of every page for approval stamp.
- 3) Provide a scaled site plan or plot plan the following information at a minimum:
  - a) Location of all fire apparatus access roads and fire apparatus turnarounds for dead-end roadways.
  - b) Dimensions indicating width, length, and radii of all turns for all fire access roads.
  - c) Surfacing specifications of fire access roads, including pavement type and thickness. May also require a report from a registered engineer for certain conditions.

**SAN BERNARDINO COUNTY FIRE PROTECTION DISTRICT  
COMMUNITY SAFETY DIVISION**



620 South 'E' Street  
San Bernardino, CA 92415-0179  
(909) 386-8400

Standard Number

**A - 1**

Revision Date:  
July 1, 2023

**FIRE PREVENTION STANDARD**

**FIRE APPARATUS ACCESS ROAD DESIGN, CONSTRUCTION AND MAINTENANCE**

- d) Gradient, camber (cross slope) and crown of all roadways used for fire access, indicated in percentage at regular intervals (can be submitted on a grading plan and with topographic lines).
- e) Locations of any types of obstructions to fire access roads. (See also SBCFPD standard A-3)
- f) The locations of all temporary and permanent structures, outside storage yards.
- g) Location of all fire protection water sources (hydrants, tanks, etc.).
- h) Locations of all parking areas, landscaping areas, walkways, and any other adjacent areas.
- i) Location of significant hazards (i.e., flammable or combustible liquids, hazardous materials, or LPG tanks).

**DEFINITIONS**

EMERGENCY VEHICLE ACCESS (EVA) - A road or other passageway developed to allow the passage of fire apparatus. An emergency vehicle access is not necessarily intended for vehicular traffic other than fire apparatus.

FIRE APPARATUS ACCESS ROAD - A road that provides fire apparatus access from a fire station to a facility, building or structure or portion thereof. This is a general term inclusive of all other terms such as fire lane, public street, private street, parking lot drive aisle, driveway or access roadway.

AERIAL FIRE APPARATUS ACCESS ROAD - A roadway that provides a location for safe operation of aerial fire apparatus, such as a ladder truck.

**GENERAL**

- 1) All access roads shall meet minimum fire apparatus access road requirements, including width, distance, turnarounds and height limitations or as approved by the Fire Code Official.
- 2) Fire apparatus access roads shall be provided to within one hundred and fifty (150) feet of all exterior portions of the first story of every building, facility or structure as measured by an approved route around the exterior of the building or structure.
- 3) For the purposes of determining adequate fire access as discussed above, "approved route" is the distance measured along a path that simulates the route a firefighter may take to extend a hose line around the exterior of a structure from a fire engine parked on the nearest fire apparatus access road. This shall be measured starting from the edge of the roadway or curb and up to the exterior wall of the building. Under most circumstances, the approved route will not be a straight line. Fences, planters, other structures, topography and any significant changes in elevation must be considered when determining whether a building or structure is accessible from a particular location on the fire access roadway. **(See Diagram A-1.1)**

**SAN BERNARDINO COUNTY FIRE PROTECTION DISTRICT  
COMMUNITY SAFETY DIVISION**



620 South 'E' Street  
San Bernardino, CA 92415-0179  
(909) 386-8400

Standard Number

**A - 1**

Revision Date:  
July 1, 2023

**FIRE PREVENTION STANDARD**

**FIRE APPARATUS ACCESS ROAD DESIGN, CONSTRUCTION AND MAINTENANCE**

**NUMBER REQUIRED**

- 1) For new residential development, additional points of access will be determined by the number of existing or future dwelling units that the roadway will provide fire access to, as well as by measuring the length of the roadway.
  - a) For one and two-family developments, a minimum of two points of access, meeting the requirements of the SBCFPD Standards are required when serving more than thirty (30) dwelling units.
- 2) In all commercial, multi-family and industrial development, a minimum of two or more separate points of fire access into a site or premises, which meet the requirements of the SBCFPD Standards shall be provided whenever fire apparatus access roadways are required onsite. **(See Diagram A-1.3)**
  - a) For development projects that are constrained with practical difficulties in providing two points of fire access, one point of fire access for emergency ingress and egress shall be allowed at the discretion of the Fire Code Official if it is unobstructed with no gates or other barriers, provides a minimum of thirty-five (35) feet in width, and provides access to buildings or structures with a combined aggregate square footage totaling no more than sixty-two thousand (62,000) square feet and no more than thirty (30) feet or three (3) stories in height.
  - b) When a secondary point of fire access into a development is required, it may be permitted to be an Emergency Vehicle Access (EVA) with the approval of the Fire Code Official. The EVA shall be secured with a gate or other barrier acceptable to the Fire Code Official. (See SBCFPD Standard A-3.)
- 3) To be considered a separate point of fire access, such access shall be located at least one half (1/2) of the diagonal distance of the development area served, apart from another point of fire access. This requirement may be modified due to practical difficulties as described above with the approval of the Fire Code Official.
- 4) The Fire Code Official is authorized to require more than two means of fire access based on the potential for impairment of roadways by vehicle congestion, condition of terrain, proximity to wildfire risk areas, or other factors that could limit access. In addition, certain uses or areas may require additional provisions for evacuation of large numbers of the public during major disasters.

**LOCATIONS**

- 1) In all development except one and two-family residential, fire access roads shall be located according to the following:
  - a) Whenever possible, access roads shall run parallel to the entire length of the building.

**SAN BERNARDINO COUNTY FIRE PROTECTION DISTRICT  
COMMUNITY SAFETY DIVISION**



620 South 'E' Street  
San Bernardino, CA 92415-0179  
(909) 386-8400

Standard Number

**A - 1**

Revision Date:  
July 1, 2023

**FIRE PREVENTION STANDARD**

**FIRE APPARATUS ACCESS ROAD DESIGN, CONSTRUCTION AND MAINTENANCE**

- b) The roadway shall not be closer than ten (10) feet or farther than thirty (30) feet from the building as measured from the face of the curb or edge of the access roadway to the exterior wall or projection of the building or structure. **(See Diagram A-1.4)**
  - c) Where aerial fire apparatus roads are required as defined in this Standard, access roads shall be located along multiple sides of the building as approved by the Fire Code Official, to facilitate aerial ladder operations.
  - d) Buildings less than 50,000 square feet and greater than 100 feet in depth shall be provided with fire access roadways on two (2) sides, one of which shall be on the longest side.
  - e) Buildings that are 50,000 square feet or larger shall have fire access roadways provided on three (3) sides, two (2) of which will be on the longest sides.
  - f) Buildings which exceed 100,000 square feet shall have fire access roadways provided on all sides.
  - g) Buildings that are four (4) or more stories or forty (40) feet or more in height shall have fire access roadways provided on all sides.
- 2) For facilities where fire apparatus access is needed but where no occupiable structures exist, a twenty-six (26) foot wide road shall be provided around the entire interior perimeter of the facility, with interior access roads twenty (20) feet wide and spaced no further than six hundred (600) feet apart.

**DIMENSIONS**

- 1) Fire apparatus access roadway width shall be measured from the face of a vertical curb, the edge of the roadway pavement, flow line of a rolled curb, or the projection of a building. **(See Diagram A-1.5)**
- 2) Fire apparatus access roadways serving all buildings, structures or facilities, shall be a minimum of twenty-six (26) feet in unobstructed width. See (a) through (d) below for exceptions.
  - a) Residential driveways that provide fire access to not more than two (2) single family dwellings and accessory structures shall be a minimum of twelve (12) feet in width.
  - b) Fire apparatus access roadways serving buildings that are three (3) or more stories or thirty (30) feet or more in height shall be a minimum of thirty (30) feet in unobstructed width.
  - c) When approved by the Fire Code Official, in Mountain Region areas as designated by the County or where topographical constraints exist, fire apparatus access roads that are less than the minimum width, but no less than twenty (20) feet in width, shall be permitted. Such roadways shall have turnouts that are a minimum of six (6') feet in width and fifty (50') feet in length and spaced at approximately every six hundred (600') feet. If fire hydrants are located on access roads, the turn-out shall be located at each fire hydrant and other points as determined necessary for fire protection and emergency response. **(See Diagram A-1.8)**

**SAN BERNARDINO COUNTY FIRE PROTECTION DISTRICT  
COMMUNITY SAFETY DIVISION**



620 South 'E' Street  
San Bernardino, CA 92415-0179  
(909) 386-8400

Standard Number

**A - 1**

Revision Date:  
July 1, 2023

**FIRE PREVENTION STANDARD**

**FIRE APPARATUS ACCESS ROAD DESIGN, CONSTRUCTION AND MAINTENANCE**

- d) One-way fire access roadways and roadways that have raised medians shall have an unobstructed one-way width of twenty (20) feet with signage posted 'per SBCFPD Standard A-2. Such medians shall be a maximum of fifty (50) feet in width except where approved by the Fire Code Official. Roadways with raised medians shall have intersections or median breaks located a maximum of six hundred (600) feet apart or as approved by the Fire Code Official. **(See Diagram A-1.7)**
- 3) All fire access roadways shall be no less than fourteen (14) feet six (6) inches in unobstructed vertical clearance, as measured from the roadway surface at the highest elevation to the lowest point of any obstruction.
- 4) All dead-end fire access roadways that exceed one hundred fifty (150') feet in length shall be provided with a turn-around in accordance with the "TURNAROUNDS" section of this Standard. The length of a roadway for the purposes of this Standard shall be measured from (A) the center line of the intersecting roadway that provides at least two points of access to (B) the center point of the dead-end roadway terminus, such as a cul-de-sac or other turnaround. **(See Diagram A-1.2)**  
The maximum length of dead-end fire access roadways shall be:
  - a) Six hundred (600) feet in length in all residential and commercial development.
  - b) One thousand (1000) feet in length in industrial development.
  - c) Three hundred fifty (350) feet in length for development within a Fire Safety Overlay District as defined by the County Development Code.
- 5) Parking of vehicles shall not be allowed to obstruct fire apparatus access at any time. The following criteria shall be used to determine parking allowed on fire access roadways:
  - a) Parking is not permitted on roadways that are less than thirty-two (32) feet in width.
  - b) Roadways that are a minimum of thirty-two (32) feet in width but less than forty (40) feet in width may have parallel parking on one (1) side of the roadway in accordance with County or City Standards.
  - c) Roadways that are a minimum of forty (40) feet in width may be designated to have parallel parking on both sides of the roadway. For higher density development, public or private streets that are a minimum of thirty-six (36) feet in width may be allowed to have parking on both sides of the street with the approval of the Fire Code Official, taking into consideration additional access provisions and other factors.
  - d) In addition, parking that is perpendicular or diagonal to the edge of the roadway shall not obstruct the required minimum width of twenty-six (26) feet for fire access. **(See Diagram A-1.6)**

**SAN BERNARDINO COUNTY FIRE PROTECTION DISTRICT  
COMMUNITY SAFETY DIVISION**



620 South 'E' Street  
San Bernardino, CA 92415-0179  
(909) 386-8400

Standard Number

**A - 1**

Revision Date:  
July 1, 2023

**FIRE PREVENTION STANDARD**

**FIRE APPARATUS ACCESS ROAD DESIGN, CONSTRUCTION AND MAINTENANCE**

**SURFACE**

- 1) All fire access roadway surfaces, except for driveways providing fire access to no more than two (2) single family dwellings or accessory structures, shall be capable of support for a fire apparatus with a gross vehicle weight of 75,000 pounds (lbs.) For design purposes, fire apparatus weight is distributed as 55,000 lbs. on the rear dual axles and 20,000 lbs. on the front axle. When required by the Fire Code Official, the design of fire access roadways shall bear the stamp of a registered professional engineer in order to verify that they meet this requirement.
- 2) Fire access roadways shall be paved with a concrete or asphalt material in order to provide "all weather" safe driving conditions. The appropriate thickness of surface materials and base materials shall be determined by a qualified engineer and subject to the approval of the County or City having jurisdiction.
- 3) Planted materials that are retained by an engineered solid system such as "Turf Block®" or "Grass-crete®" may be used for fire apparatus access surfacing, with approval of the Fire Code Official, for limited or isolated areas no more than fifty (50) feet in length and where road grades do not exceed two percent (2%). Such areas shall be clearly signed as Emergency Vehicle Access per SBCFPD Standard A-3, Diagram A-3.1. These, as well as other alternate paving materials such as stone, concrete pavers, chip seal or slag, shall be evaluated based on their ability to support imposed load of a fire apparatus and shall be immediately recognizable to emergency responders as a drivable surface.
- 4) Where no paved roadways exist, and road grades do not exceed eight percent (8%), and where serving not more than two (2) one or two family dwellings or accessory buildings, roads may be constructed with approved native materials or gravel compacted to eighty-five percent (85%) compaction.
- 5) Where serving facilities with no permanent occupiable structures, the Fire Code Official may allow alternate fire access roadway surfaces that are designed or evaluated by a qualified professional engineer and that demonstrate equivalent reliability and stability.

**GRADIENT**

- 1) Generally, the grade of a fire apparatus access road shall be a maximum of twelve percent (12%) at any point.
- 2) Fire apparatus access roadways or driveways may be increased to fourteen percent (14%) for a distance not to exceed 500 feet with the approval of the Fire Code Official.
- 3) The grade of a driveway providing fire access to no more than two (2) one or two-family dwellings may be increased to a maximum of sixteen percent (16%) for a distance not to exceed 500 feet in areas in which County or City Development Codes allow such increases and with the approval of the Fire Code Official.

**SAN BERNARDINO COUNTY FIRE PROTECTION DISTRICT  
COMMUNITY SAFETY DIVISION**



620 South 'E' Street  
San Bernardino, CA 92415-0179  
(909) 386-8400

Standard Number

**A - 1**

Revision Date:  
July 1, 2023

**FIRE PREVENTION STANDARD**

**FIRE APPARATUS ACCESS ROAD DESIGN, CONSTRUCTION AND MAINTENANCE**

- 4) Grades across the width of a road section or within a turnaround area as described below shall not exceed five percent (5 %).
- 5) In order to accommodate proper angles of approach and departure, gradient in fire access roads shall not exceed a five percent (5%) change along any ten (10) foot section. **(See Diagram A-1.9)**

**TURNING RADIUS**

- 1) All turns within fire access roadways that accommodate two-way traffic of fire apparatus shall be a minimum of nineteen feet (19') inside radius and forty-five feet (45') outside radius. **(See Diagram A-1.10)**
- 2) Fire access roadways that accommodate one-way traffic of fire apparatus, as well as roadways that have limited traffic such as onsite drive aisles, shall be a minimum of nineteen feet (19') inside radius and thirty-one feet (31') outside radius. **(See Diagram A-1.10)**
- 3) Subject to the approval of the Fire Code Official, a computer model fire apparatus turning template with the below dimensions can be used for determining the appropriate radius.
  - a) Fire engine wheelbase of one hundred eighty-three inches (183") and with an overall length of three hundred twelve inches (312").
  - b) Aerial apparatus with a tractor wheelbase of one hundred eighty inches (180") and a tiller wheelbase of three hundred sixty inches (360") with an overall length of seven hundred thirty-two inches (732").
- 4) A minimum fifty (50) foot straight section of roadway must be provided between radius turns within fire access roadways, measured from the end of one radius turn to the beginning of the next. **(See Diagram A-1.11)** A turning template may also be used to modify this requirement.

**TURNAROUNDS**

- 1) An approved fire apparatus turnaround in accordance with this section is required when fire access roadways exceed one hundred fifty (150) feet in length.
- 2) Driveways, alleys, and other private roadways that are not intended for public access may provide a "hammerhead" style turnaround. **(See Diagram A-1.12)**
- 3) Public and private streets that are intended for public right-of-way access shall terminate in an approved cul-de-sac with a minimum radius of forty-five (45) feet. Within higher density development, cul-de-sacs that are a minimum of thirty-eight (38) feet in radius may be allowed with the approval of the Fire Code Official, taking into consideration potential for parking and other factors. **(See Diagram A-1.13)**

**SAN BERNARDINO COUNTY FIRE PROTECTION DISTRICT  
COMMUNITY SAFETY DIVISION**



620 South 'E' Street  
San Bernardino, CA 92415-0179  
(909) 386-8400

Standard Number

**A - 1**

Revision Date:  
July 1, 2023

**FIRE PREVENTION STANDARD**

**FIRE APPARATUS ACCESS ROAD DESIGN, CONSTRUCTION AND MAINTENANCE**

**INSTALLATION**

- 1) All fire access roadways required by the Fire Code and this Standard shall be installed to an extent that will provide all-weather paved access for emergency vehicles prior to combustibles being brought to the site or combustible construction taking place. The Fire Code Official shall determine the adequacy of fire access roads during construction.
- 2) All secondary points of fire access, including those that are EVA only, shall be installed prior to the first phase or the beginning of combustible construction. Subject to the approval of the Fire Code Official, additional points of access may be installed during later phases of construction, provided all other requirements of this Standard are met and all access roads and points of access are installed prior to final for occupancy.
- 3) Prior to final approval for any development project, fire access roadways shall be complete with final lifts of asphalt, curbs and gutters, fire hydrant markers in accordance with SBCFPD Standard W-2, and approved signage and striping in accordance with SBCFPD Standard A-2.

**TEMPORARY FIRE ACCESS ROADS**

- 1) When approved by the Fire Code Official, temporary access roads that meet all applicable requirements of SBCFPD Standards may be installed during construction in lieu of permanent access roadways and maintained in place for a maximum period of one (1) year.
- 2) Temporary fire access roads shall be designed by a registered professional engineer and submitted to the SBCFPD for approval in accordance with this Standard. Such roadways may be designed and constructed of any materials that will provide safe, all-weather drivable surface, provided these are evaluated by the design engineer and meet all applicable requirements of this Standard.

**MAINTENANCE**

- 1) All fire apparatus access roads, private or public, shall be maintained unobstructed and in safe, drivable condition for emergency vehicle access, at all times by the property owner or other responsible party.
- 2) In areas subject to snowfall, all roadways used for fire access shall be cleared of snow and repaired on a continual basis.
- 3) Landscaping and any other vegetation shall be maintained and cleared horizontally from the edges and extending vertically to fourteen (14) feet, six (6) inches in height for all fire access roads. Consideration should be given as to the size of mature growth, for each species, so plants will not impede firefighting operations or access.
- 4) All roadways as well as cul-de-sacs and other required turnarounds shall be free of obstructions, including storage or the parking of vehicles.



**SAN BERNARDINO COUNTY FIRE PROTECTION DISTRICT  
COMMUNITY SAFETY DIVISION**



620 South 'E' Street  
San Bernardino, CA 92415-0179  
(909) 386-8400

Standard Number

**A - 1**

Revision Date:  
July 1, 2023

**FIRE PREVENTION STANDARD**

**FIRE APPARATUS ACCESS ROAD DESIGN, CONSTRUCTION AND MAINTENANCE**

**RECIPROCAL EMERGENCY AND FIRE APPARATUS ACCESS ROADS**

- 1) Emergency and fire apparatus access roads passing through multiple parcels shall have reciprocal agreements complying with the requirements of the San Bernardino County Fire Protection District Fire Code Ordinance, Section 32.

**FIREFIGHTER ACCESS TO BUILDINGS**

- 1) Fences, walls, landscaped areas, or other obstructions that may inhibit firefighters from extending hose lines from a fire apparatus parked on a fire access roadway to any building shall have a minimum four-foot (4'-0") gates or openings provided, at locations acceptable to the Fire Code Official.
- 2) A minimum four foot (4'-0") paved pathway shall be provided from fire access roadways to all fire access doors.

**FIRE ACCESS ROADS WITHIN STATE RESPONSIBILITY AREAS AND STATE PROJECTS**

- 1) Title 14, California Code of Regulations, State Responsibility Areas Fire Safe Regulations shall be met or exceeded in all developments within State Responsibility Areas, Very High Fire Hazard Severity Zones, and State regulated projects within San Bernardino County Fire Protection District's jurisdiction. See SBCFPD Standard SRA-1.

**AERIAL FIRE APPARATUS ACCESS ROADS**

- 1) Approved aerial fire apparatus access roads shall be provided for buildings that are three (3) stories or more or 30 feet or more in height. Aerial fire apparatus access roads shall have a minimum unobstructed width of thirty (30) feet.
- 2) Overhead utilities, power lines and any other items that could be considered obstructions shall not be located within the aerial fire apparatus access area.
- 3) Aerial fire apparatus access shall be provided in locations to enable rapid and safe access to the roof of the building. The locations of all roof access points shall be approved by the Fire Code Official.

**SAN BERNARDINO COUNTY FIRE PROTECTION DISTRICT  
COMMUNITY SAFETY DIVISION**



620 South 'E' Street  
San Bernardino, CA 92415-0179  
(909) 386-8400

Standard Number

**A - 1**

Revision Date:  
July 1, 2023

**FIRE PREVENTION STANDARD**

**FIRE APPARATUS ACCESS ROAD DESIGN, CONSTRUCTION AND MAINTENANCE**

**DIAGRAM A-1.1: ROUTE OF TRAVEL AROUND BUILDINGS**

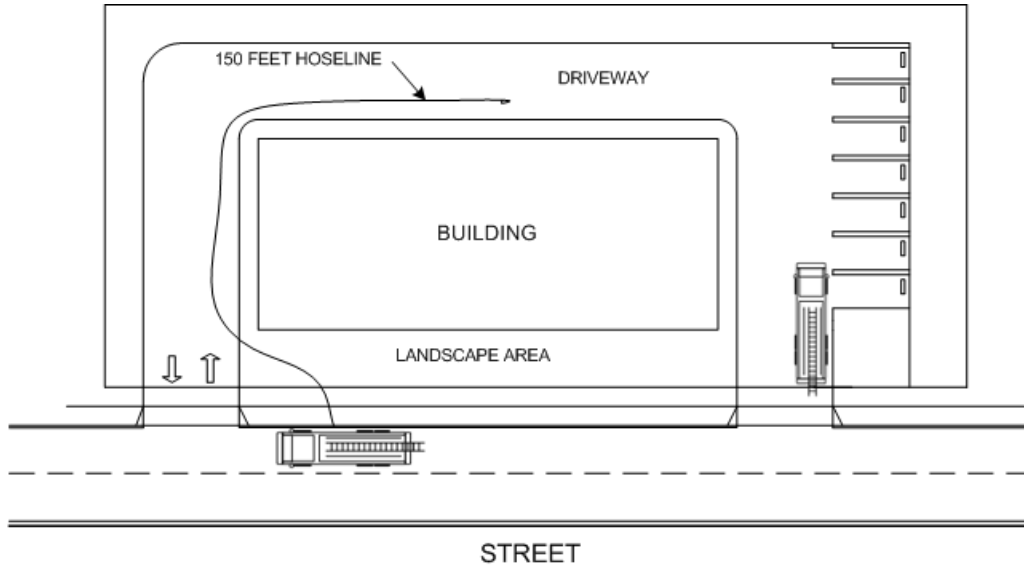

**DIAGRAM A-1.2: METHOD OF MEASURING CUL-DE-SAC LENGTH**

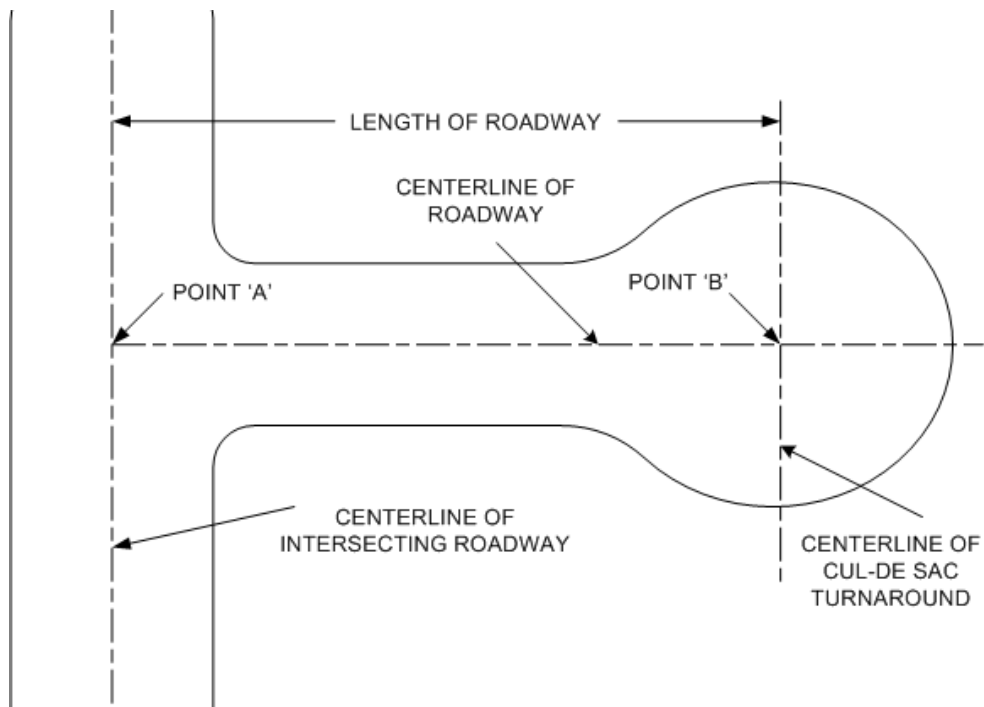

SAN BERNARDINO COUNTY FIRE PROTECTION DISTRICT  
COMMUNITY SAFETY DIVISION



620 South 'E' Street  
San Bernardino, CA 92415-0179  
(909) 386-8400

Standard Number

**A - 1**

Revision Date:  
July 1, 2023

**FIRE PREVENTION STANDARD**

**FIRE APPARATUS ACCESS ROAD DESIGN, CONSTRUCTION AND MAINTENANCE**

**DIAGRAM A-1.3: MULTIPLE POINTS OF ACCESS**

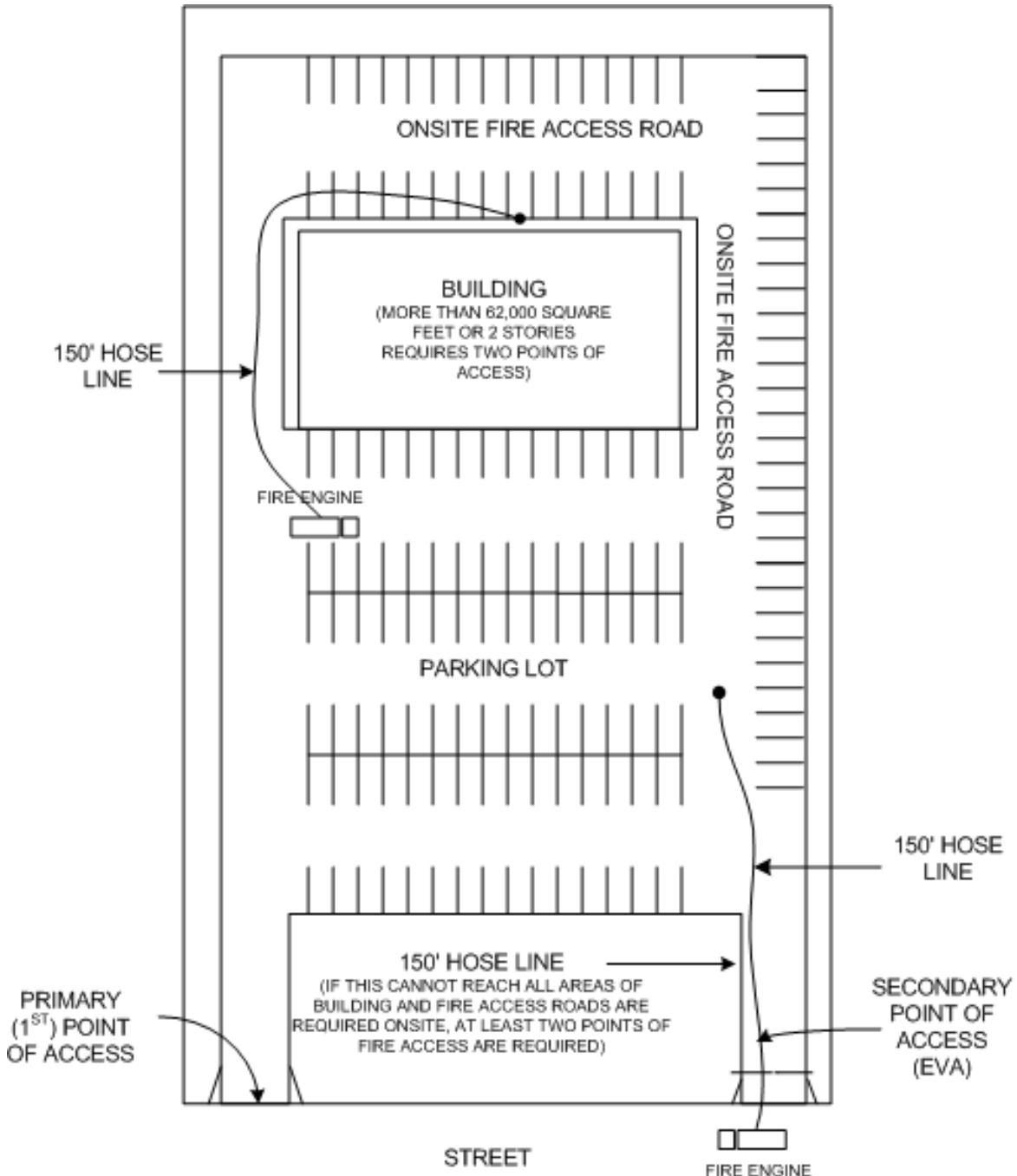

**SAN BERNARDINO COUNTY FIRE PROTECTION DISTRICT  
COMMUNITY SAFETY DIVISION**



620 South 'E' Street  
San Bernardino, CA 92415-0179  
(909) 386-8400

Standard Number

**A - 1**

Revision Date:  
July 1, 2023

**FIRE PREVENTION STANDARD**

**FIRE APPARATUS ACCESS ROAD DESIGN, CONSTRUCTION AND MAINTENANCE**

**DIAGRAM A-1.4: SIDES OF BUILDING ACCESS**

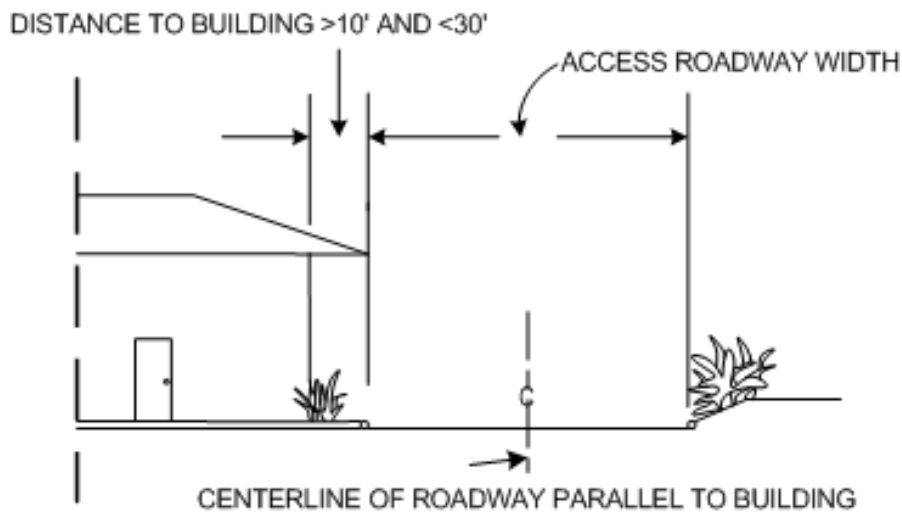
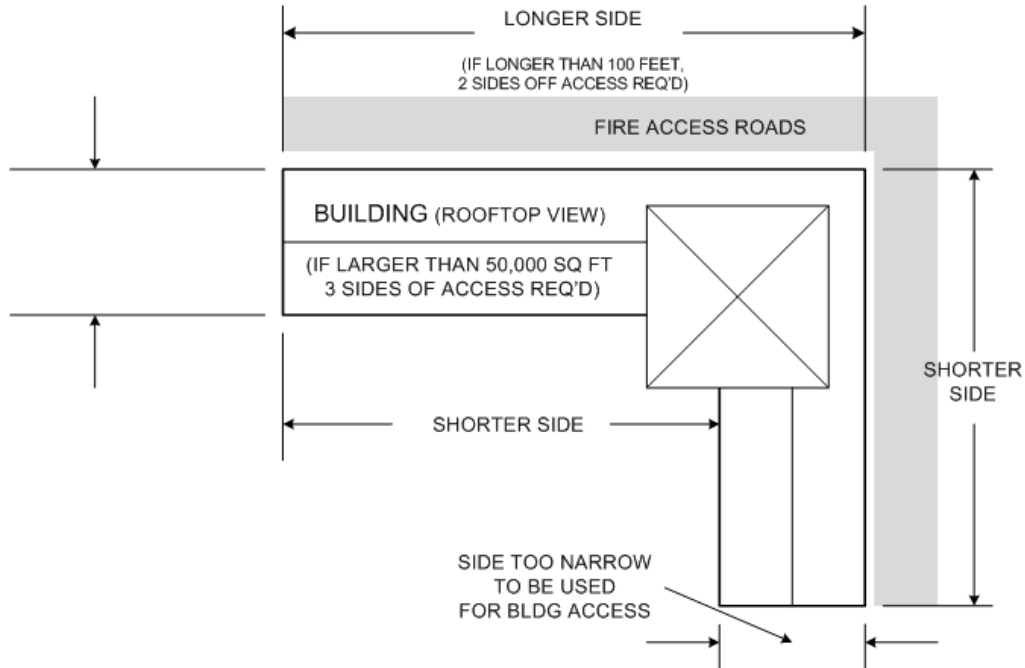

**SAN BERNARDINO COUNTY FIRE PROTECTION DISTRICT  
COMMUNITY SAFETY DIVISION**



620 South 'E' Street  
San Bernardino, CA 92415-0179  
(909) 386-8400

Standard Number

**A - 1**

Revision Date:  
July 1, 2023

**FIRE PREVENTION STANDARD**

**FIRE APPARATUS ACCESS ROAD DESIGN, CONSTRUCTION AND MAINTENANCE**

**DIAGRAM A-1.5: ROADWAY MEASUREMENT DETAIL**

**CURBED ROAD**

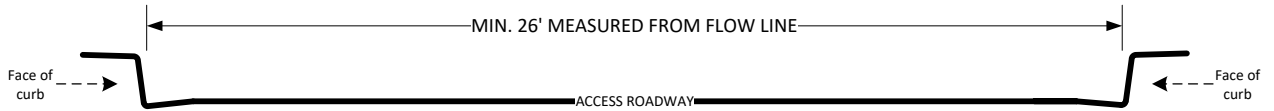

**FLAT ROAD**

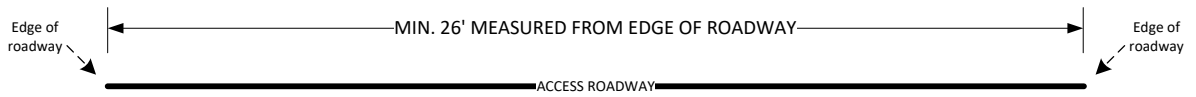

**ROLLED CURB**

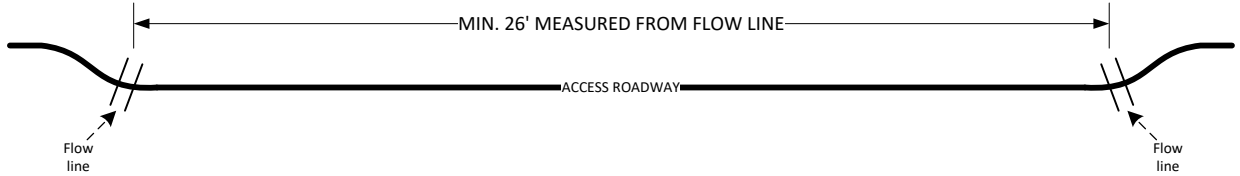

**EDGE OF BUILDING OR PROJECTION**

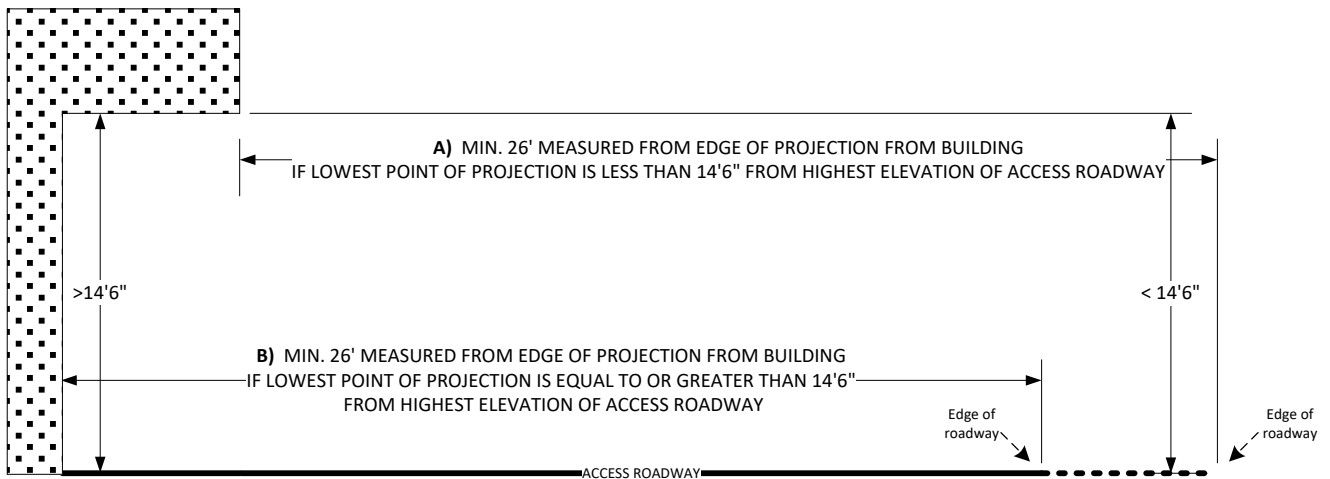



**SAN BERNARDINO COUNTY FIRE PROTECTION DISTRICT  
COMMUNITY SAFETY DIVISION**

620 South 'E' Street  
San Bernardino, CA 92415-0179  
(909) 386-8400

Standard Number

**A - 1**

Revision Date:  
July 1, 2023

**FIRE PREVENTION STANDARD**

**FIRE APPARATUS ACCESS ROAD DESIGN, CONSTRUCTION AND MAINTENANCE**

**DIAGRAM A-1.6: PARKING ON FIRE ACCESS ROADWAYS**

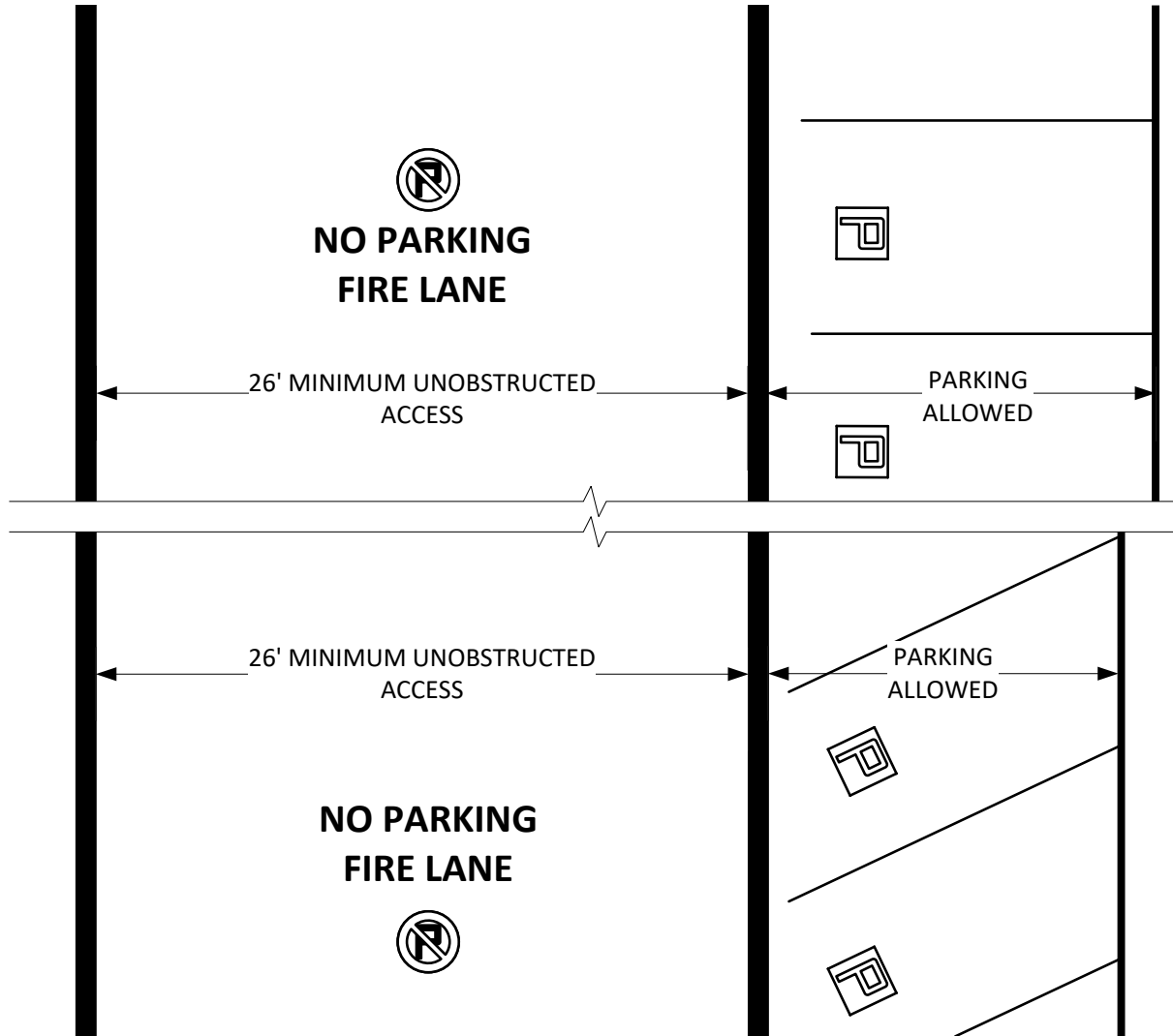

**SAN BERNARDINO COUNTY FIRE PROTECTION DISTRICT  
COMMUNITY SAFETY DIVISION**



620 South 'E' Street  
San Bernardino, CA 92415-0179  
(909) 386-8400

Standard Number

**A - 1**

Revision Date:  
July 1, 2023

**FIRE PREVENTION STANDARD**

**FIRE APPARATUS ACCESS ROAD DESIGN, CONSTRUCTION AND MAINTENANCE**

**DIAGRAM A-1.7: ROADWAY MEDIAN BREAKS**

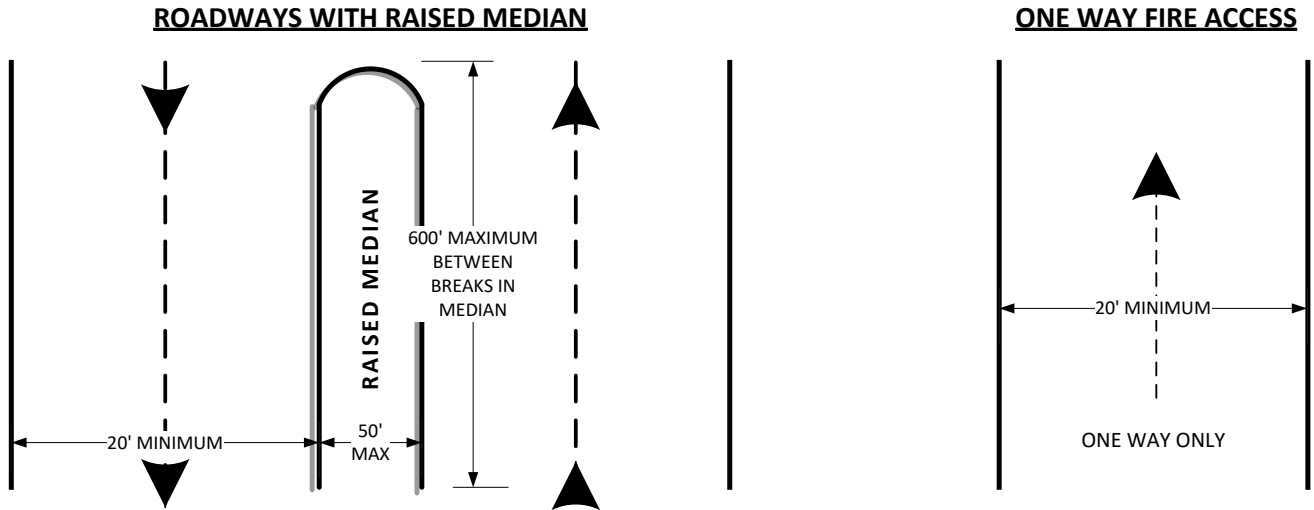

**DIAGRAM A-1.8: ROADWAY TURNOUT DETAILS**

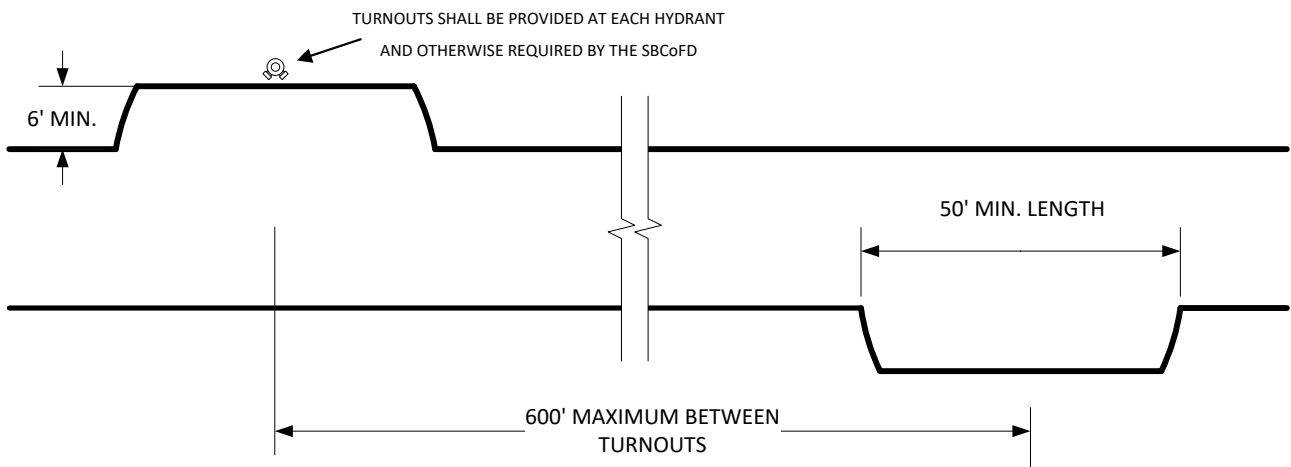

**SAN BERNARDINO COUNTY FIRE PROTECTION DISTRICT  
COMMUNITY SAFETY DIVISION**



620 South 'E' Street  
San Bernardino, CA 92415-0179  
(909) 386-8400

Standard Number

**A - 1**

Revision Date:  
July 1, 2023

**FIRE PREVENTION STANDARD**

**FIRE APPARATUS ACCESS ROAD DESIGN, CONSTRUCTION AND MAINTENANCE**

**DIAGRAM A-1.9: ROADWAY GRADE DETAIL**

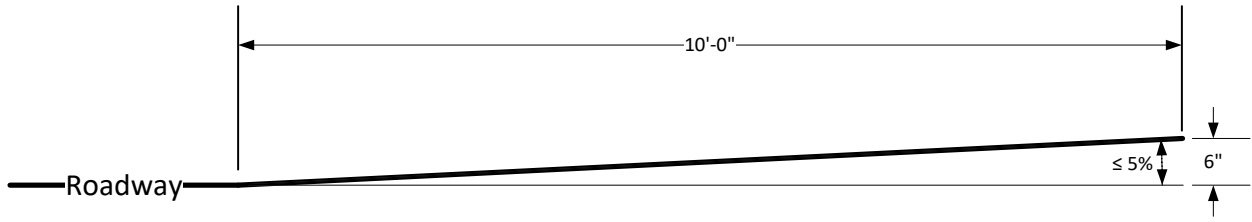

**DIAGRAM A-1.10: TURNING RADIUS DETAIL**

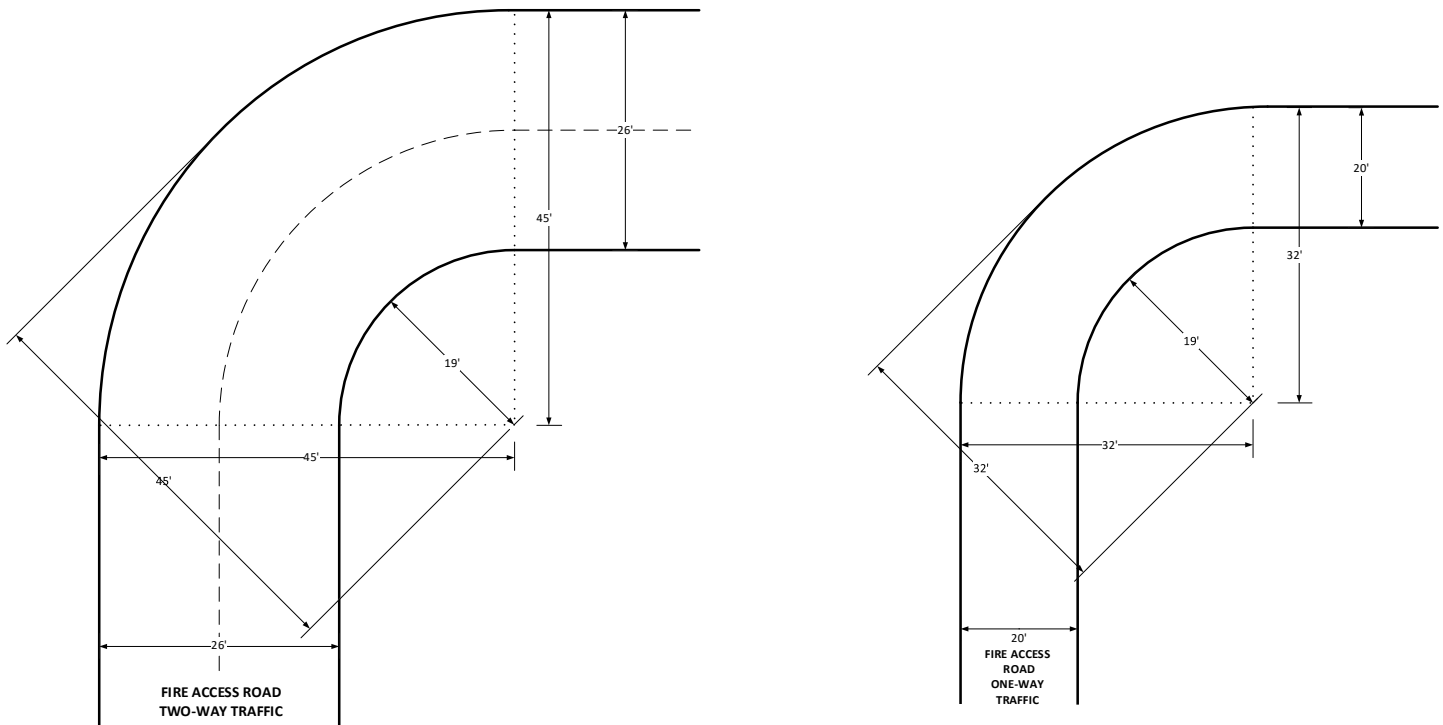



**SAN BERNARDINO COUNTY FIRE PROTECTION DISTRICT  
COMMUNITY SAFETY DIVISION**



620 South 'E' Street  
San Bernardino, CA 92415-0179  
(909) 386-8400

Standard Number

**A - 1**

Revision Date:  
July 1, 2023

**FIRE PREVENTION STANDARD**

**FIRE APPARATUS ACCESS ROAD DESIGN, CONSTRUCTION AND MAINTENANCE**

**DIAGRAM A-1.11: ROADWAY CURVES**

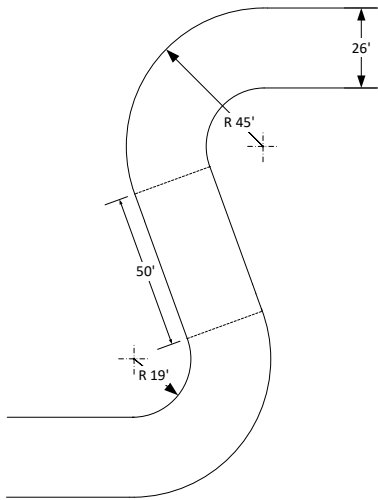

**DIAGRAM A-1.12: HAMMERHEAD TURNAROUND DETAIL**

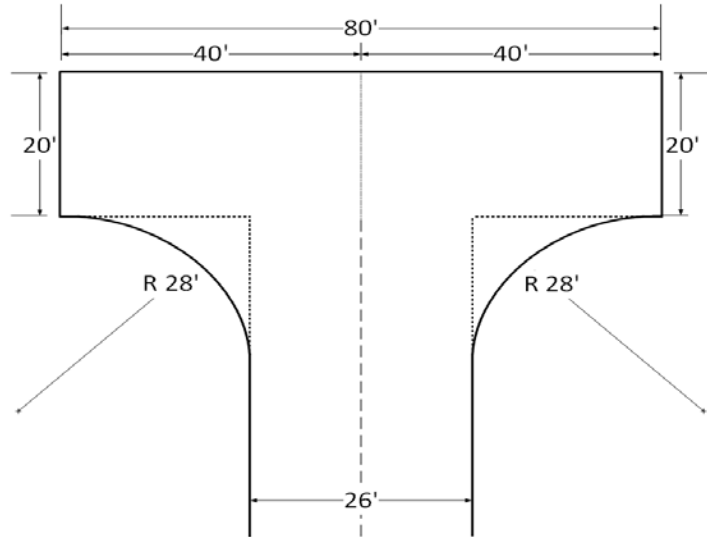

**DIAGRAM A-1.13: CUL-DE-SAC TURNAROUND DETAIL**

